

Serrure non identifiée sans shunt sur porte en fer forgé

Kit **GF-S**

Produit à remplacer
Serrures pour portes en fer forgé

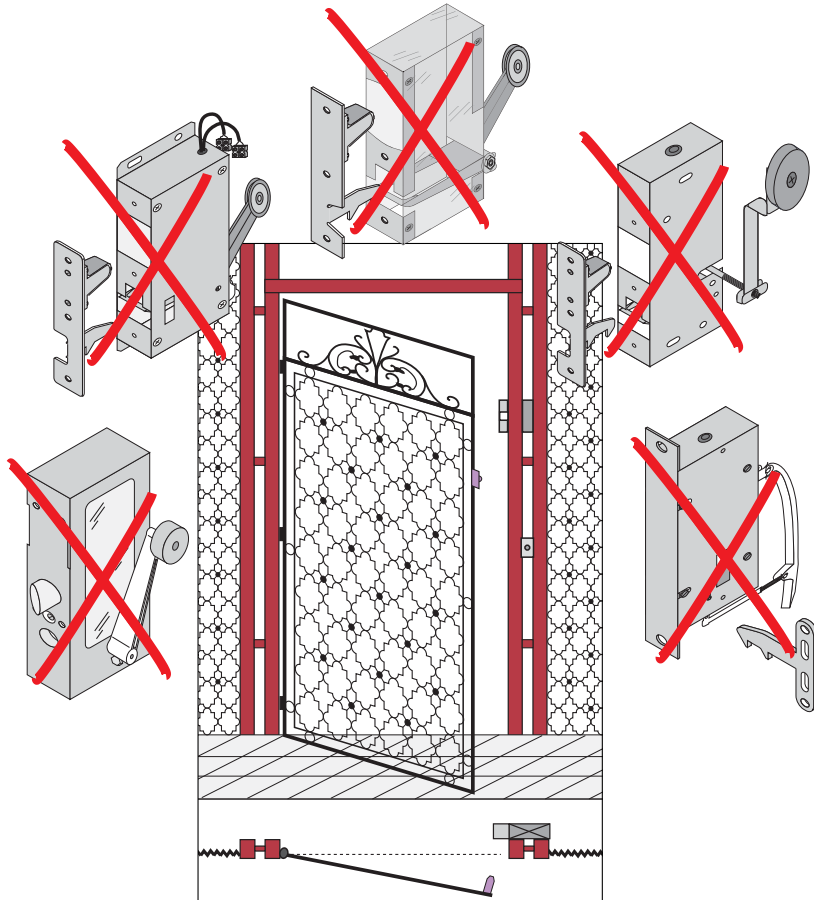

Produit de remplacement

LR 180 ** GF-S prudhomme S.a
pour porte en fer forgé (sans shunt).

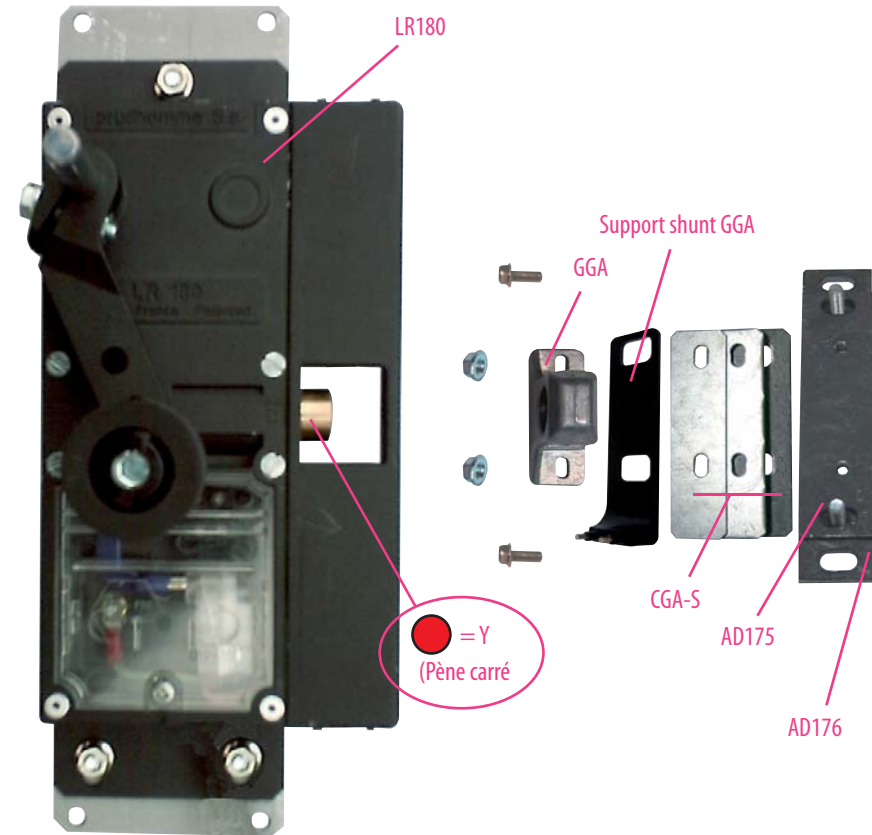

Incl. A du 12/08/2009

FP

Document non contractuel, sous réserve de modification - Reproduction interdite.

réf. : LR180 *G GF-S

réf. : LR180 *D GF-S

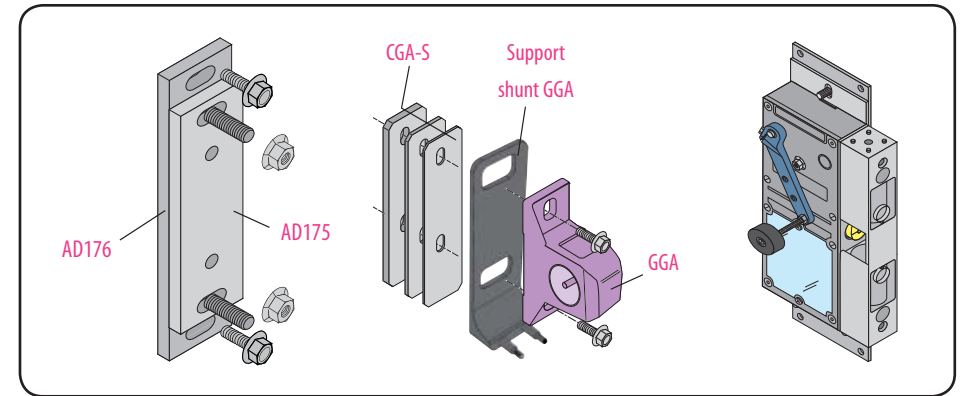
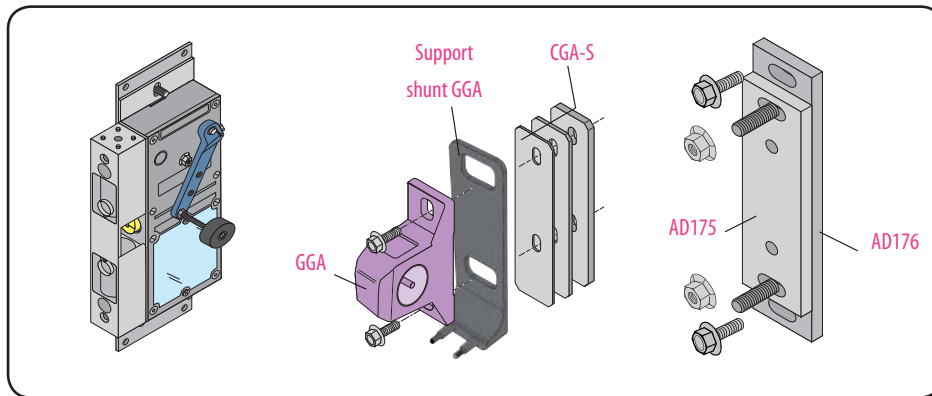
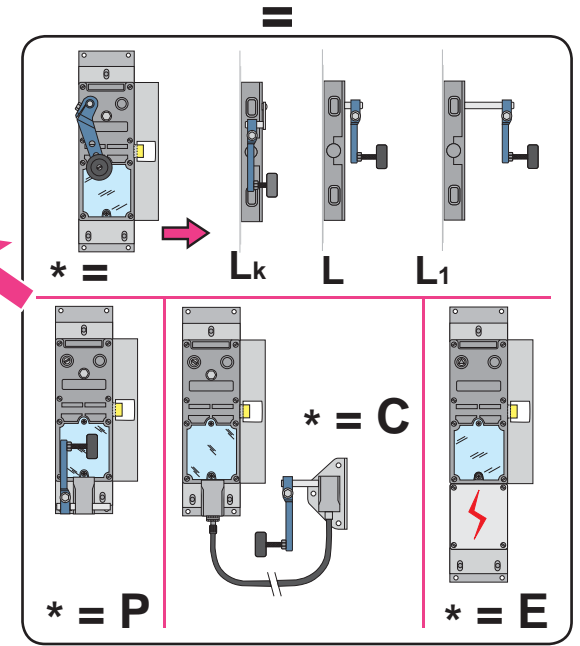
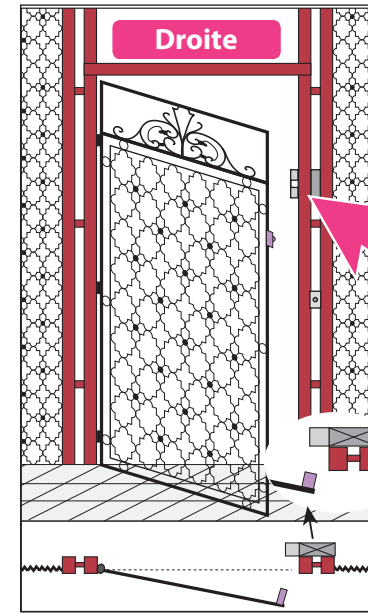
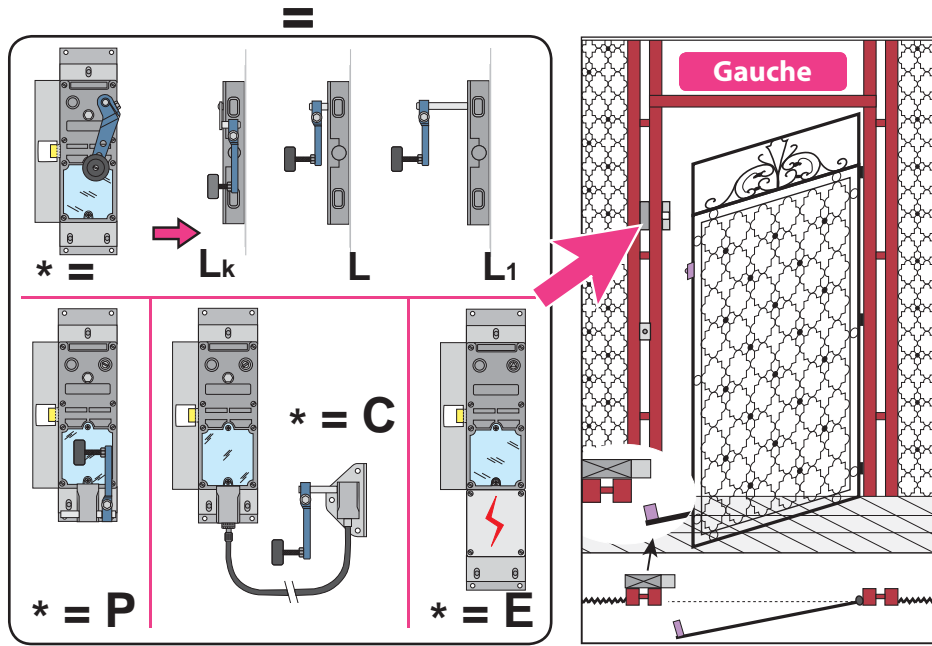

sur porte en fer forgé

Phases de montage

